

AssureFlex® Two-Leg U Style Seismic and Expansion Loop for Fire Protection

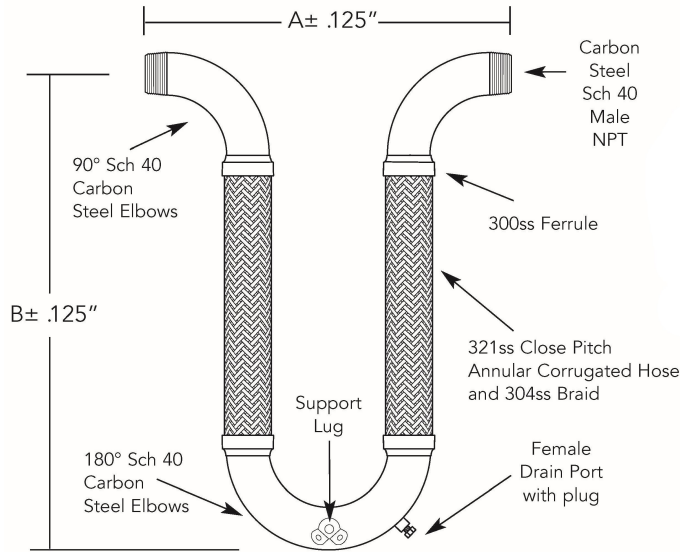

CSA standard B-51 certified.
Inspected and tested by the
Technical Standards and
Safety Authority of Canada.

QTY.	I.D. (in.)	Length (in.)		Pressure (PSI) @70° F	Drain Port (in.)	Weight (lb.)	Comments
		A (in.)	B (in.)				
	0.50	16.00	20.00	300	¼	5.5	
	0.75	16.00	21.00	300	¼	6.0	
	1.00	18.00	23.00	300	½	8.0	
	1.25	19.00	25.00	300	½	10.0	
	1.50	21.00	27.00	300	½	14.5	
	2.00	23.00	30.00	300	½	18.0	
	2.50	25.00	34.00	300	¾	29.0	
	3.00	27.00	37.00	300	¾	43.0	
	4.00	31.50	43.00	175	¾	55.0	

MOVEMENT CAPABILITY: +/- 8"

PROJECT	
CUSTOMER	
ENGINEER	
REPRESENTATIVE	
DRAWING #	



4560 Buckley Road
Liverpool, NY USA 13088-2509
315/437-1611 • Fax 315/437-1903
www.flexhose.com • 1.877.TRI FLEX