

FLEXPRESS™ FP-D/150 Externally Pressurized Guided Expansion Joints



Maximum Temperature 650°F

Design Pressure 150 PSIG • Test Pressure 225 PSIG

Qty	I.D. (In.)	Bellows Area (Sq. In.)	Length (In.)	Movement Capability (In.)		Weight (Lbs.)
				Compression	Extension	
<input type="checkbox"/>	2.00	12	39.50	8.00	1.50	60.00
			57.25	12.00	2.25	85.00
			71.50	16.00	3.00	102.00
<input type="checkbox"/>	2.50	12	39.50	8.00	1.50	65.00
			57.25	12.00	2.25	92.00
			71.50	16.00	3.00	112.00
<input type="checkbox"/>	3.00	16	37.50	8.00	1.50	82.00
			50.25	12.00	2.25	104.00
			67.50	16.00	3.00	138.00
<input type="checkbox"/>	4.00	30	38.75	8.00	1.50	127.00
			52.00	12.00	2.25	162.00
			70.00	16.00	3.00	216.00
<input type="checkbox"/>	5.00	42	36.00	8.00	1.50	170.00
			48.00	12.00	2.25	212.00
			60.50	16.00	3.00	296.00
<input type="checkbox"/>	6.00	53	36.25	8.00	1.50	184.00
			48.25	12.00	2.25	230.00
			60.75	16.00	3.00	278.00
<input type="checkbox"/>	8.00	83	38.25	8.00	1.50	260.00
			51.25	12.00	2.25	354.00
			64.75	16.00	3.00	430.00
<input type="checkbox"/>	10.00	135	40.50	8.00	2.00	364.00
			54.75	12.00	3.00	468.00
			73.25	16.00	4.00	620.00
<input type="checkbox"/>	12.00	182	42.25	8.00	2.00	455.00
			57.25	12.00	3.00	589.00
			76.75	16.00	4.00	779.00
<input type="checkbox"/>	14.00	212	42.25	8.00	2.00	529.00
			57.25	12.00	3.00	677.00
			76.75	16.00	4.00	889.00
<input type="checkbox"/>	16.00	276	42.25	8.00	2.00	575.00
			57.25	12.00	3.00	740.00
			76.75	16.00	4.00	976.00
<input type="checkbox"/>	18.00	338	42.25	8.00	2.00	633.00
			57.25	12.00	3.00	817.00
			76.75	16.00	4.00	1081.00
<input type="checkbox"/>	20.00	404	42.25	8.00	2.00	724.00
			57.25	12.00	3.00	924.00
			76.75	16.00	4.00	1214.00
<input type="checkbox"/>	22.00	481	42.25	8.00	2.00	758.00
			57.25	12.00	3.00	978.00
			76.75	16.00	4.00	1292.00
<input type="checkbox"/>	24.00	562	42.25	8.00	2.00	852.00
			57.25	12.00	3.00	1088.00
			76.75	16.00	4.00	1430.00

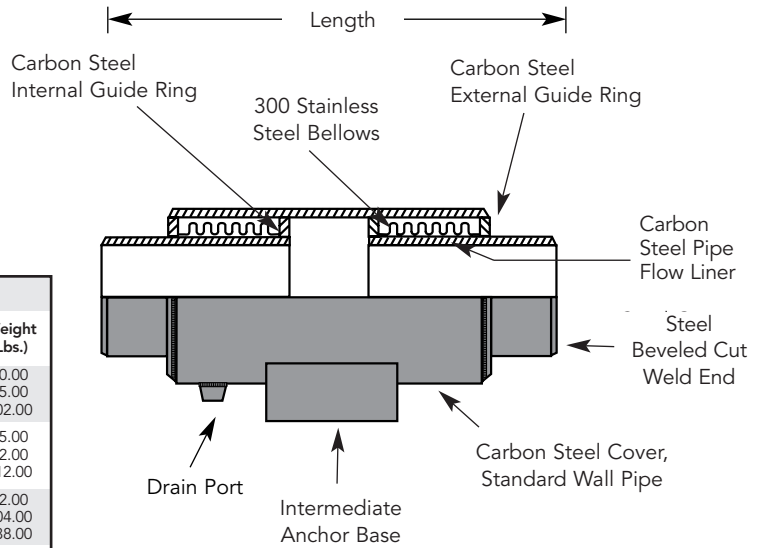

Notes



CSA standard B-51 certified. Inspected and tested by the Technical Standards and Safety Authority of Canada.



6801 Crossbow Drive
 East Syracuse, NY USA 13057-1026
 315/437-1611 • Fax 315/437-1903
 www.flexhose.com • 1.877.METAL EJ

PROJECT	
CUSTOMER	
ENGINEER	
REPRESENTATIVE	
DRAWING #	

WS201508

EXTERNALLY PRESSURIZED EXPANSION JOINTS

FP-D/150 WxW 2"-24" I.D.